

30" srok.it™ spec sheet 90CRI

material

acoustic fin

polyethylene terephthalate (PET) 12mm thick made from recycled material. 14 color options available. NRC rating: 0.25-0.75. Fireproof Level: B1

trim ring

wafer thin 3" h roll formed aluminum extrusion. 6061 T1 alloy. .100 typ. wall. available in 15 standard powder coat paint finishes listed below. premium RAL also available.

diffuser

satinice WD855 minimum 72% light transmission, light scattering, glare reduction, colorless diffusion acrylic.

optics

reflector

.064" aluminum array platform painted high reflectance (>92%) matte white powder coat provides 100% downlight. for uplight, specify under options.

LED

specification-grade LED modules with integrated batwing optics to minimize diffusion depth and increase illumination uniformity. 90+ CRI. L80>72,000 hrs. 3000K, 3500K, 4000K. white power cord standard.

driver

integral, programmable, UL class P, class2, universal input (120-277v), constant current, 0-10v controllable, 1% minimum dimming level.

mounting

5" dia. spun steel canopy in satin white is designed to mount to a 4" octagon junction box (by other). 6' tripod suspension of stainless steel cables attaches to reflector with field adjustable grippers that allow for exact AFF mounting heights. slip ring coupler at ceiling allows for easy wire connections. or select 12ft adjustable suspension (drawing below). white power cord standard.

finish

select from 15 standard powder coat paint finishes listed below.

emergency

recommend use of inverter (by other). optional WREM: wired for remote EM battery (by other).



catalog number

--	--	--	--	--	--	--

size	fin shape	fin color	CCT	lumens	painting finish	options
P2030 27.5" dia X 6" ht 24" dia X 3" ht light engine	BG boomerang 	designer SBA sesame black SGA silver gray PCA peacock OCA ocean SDA sand dune CFA coffee SWA seaweed primary RDA red ORA orange OYA orange yellow GRA green SKA sky blue BUA blue PRA purple	30 3000K 35 3500K 40 4000K	FX 2700 lm LO 4100 lm HI 4900 lm HX 7000 lm CL xxxx lm <small>custom lumens consult factory 2700 - 7000 lm</small>	AP anodized paint BS brass BU blue BZ bronze CP champagne FB flat black GM gun metal MB military blue MW matte white OR orange RD red SB satin black SS satin silver TG textured gray YO yellow	6FT 72" adj cables 12FT 12ft adj suspension BKPC black power cord and canopy SBPC silver braid power cord and white canopy UP 10% uplight WREM wired for remote EM battery pack (by other) (see note above) ELD EldoLED* LUT Lutron* <small>*consult factory</small>



See p.2 for info on P2036



job name:
 type:

42" sprok.it™ spec sheet 90CRI

material

acoustic fin

polyethylene terephthalate (PET) 12mm thick made from recycled material. 14 color options available. NRC rating: 0.25-0.75. Fireproof Level: B1

trim ring

wafer thin 3" h roll formed aluminum extrusion. 6061 T1 alloy. .100 typ. wall. available in 15 standard powder coat paint finishes listed below. premium RAL and wood finishes also available.

diffuser

satinnice WD855 minimum 72% light transmission, light scattering, glare reduction, colorless diffusion acrylic.

optics

reflector

.080" aluminum array platform painted high reflectance (>92%) matte white powder coat provides 100% downlight. for uplight, specify under options.

LED

specification-grade LED modules with integrated batwing optics to minimize diffusion depth and increase illumination uniformity. 90+ CRI. L80>72,000 hrs. 3000K, 3500K, 4000K. white power cord standard.

driver

integral, programmable, UL class P, class2, universal input (120-277v), constant current, 0-10v controllable, 1% minimum dimming level.

mounting

5" dia. spun steel canopy in satin white is designed to mount to a 4" octagon junction box (by other). 6' tripod suspension of stainless steel cables attaches to reflector with field adjustable grippers that allow for exact AFF mounting heights. slip ring coupler at ceiling allows for easy wire connections. or select 12ft adjustable suspension (drawing below). white power cord standard.

finish

select from 15 standard powder coat paint finishes listed below.

emergency

recommend use of inverter (by other). optional WREM: wired for remote EM battery (by other).



catalog number

--	--	--	--	--	--	--

size	fin shape	fin color	CCT	lumens	painting finish	options
P2042 39.5" dia X 6" ht 36" dia X 3" ht light engine	BG boomerang 	designer SBA sesame black SGA silver gray PCA peacock OCA ocean SDA sand dune CFA coffee SWA seaweed primary RDA red ORA orange OYA orange yellow GRA green SKA sky blue BUA blue PRA purple	30 3000K 35 3500K 40 4000K	FX 4900 lm LO 7400 lm HI 9200 lm HX 13900 lm CL xxxx lm <small>custom lumens consult factory 4900 - 13900 lm</small>	AP anodized paint BS brass BU blue BZ bronze CP champagne FB flat black GM gun metal MB military blue MW matte white OR orange RD red SB satin black SS satin silver TG textured gray YO yellow	6FT 72" adj cables 12FT 12ft adj suspension BKPC black power cord and canopy SBPC silver braid power cord and white canopy UP 10% uplight WREM wired for remote EM battery pack (by other) (see note above) ELD EldoLED* LUT Lutron* <small>*consult factory</small>



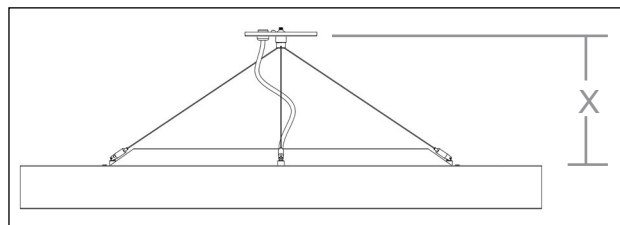
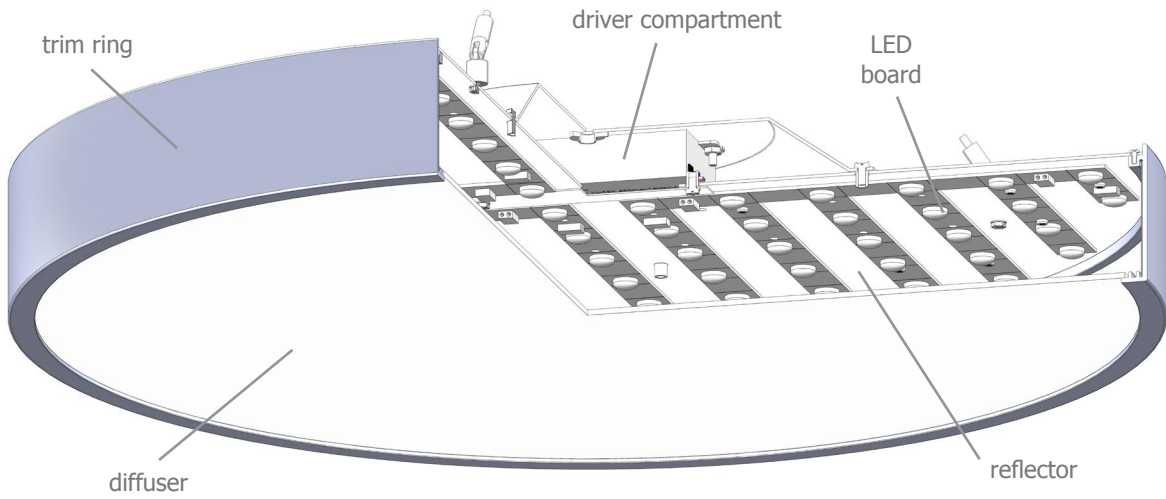
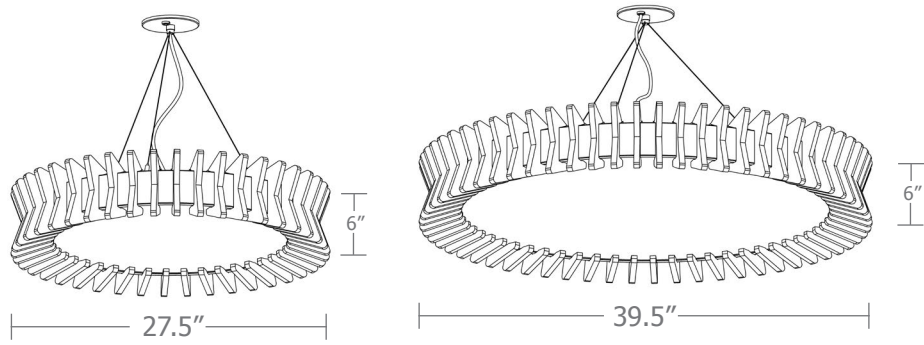







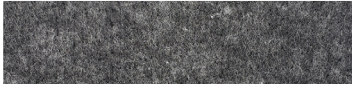





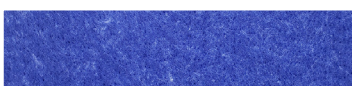





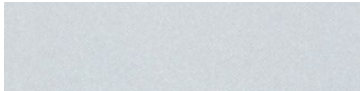

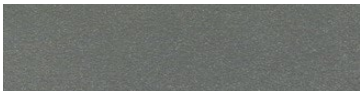
min. suspension length.

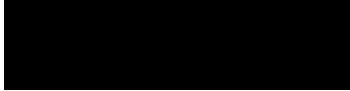
	X
P2030	6.5"
P2042	9"

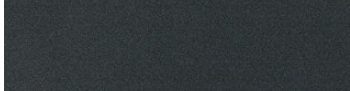
Acoustic Colors

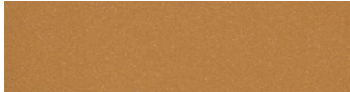
designer		primary	
	SBA sesame black		RDA red
	SGA silver gray		ORA orange
	PCA peacock		OYA orange yellow
	OCA ocean		GRA green
	SDA sand dune		SKA sky blue
	CFA coffee		BUA blue
	SWA seaweed		PRA purple

Powder Coat Paint Finishes

	MW matte white		AP anodized paint		SS satin silver
	TG textured gray		FB flat black		SB satin black
	CP champagne		BZ bronze		GM gun metal
	OR orange 2011		BU blue 5017		BS brass
	RD red 3020		YO yellow 1018		MB military blue

For accurate color verification, actual finish samples are available upon request.

